

Chemistries of Ozone for Municipal Pool and Spa Water Treatment

Facts and Fallacies

Rip G. Rice, Ph.D.

Rice International Consulting Enterprises

Ozone generated by ultraviolet (UV) radiation is used in North America for treating (mostly residential) spa and pool waters almost exclusively, while only a handful of North American municipal pools and spas are using ozone generated by corona discharge technology in accordance with well-established German teachings. On the other hand, several thousand European municipal swimming pools and spas are using corona discharge-generated ozone today at concentrations which cannot be generated effectively by UV radiation in quantities sufficient to perform simultaneous oxidation and disinfection.

To apply ozone efficaciously and cost-effectively for the treatment of municipal pool and spa waters, an understanding of its chemistry in water is essential, particularly with respect to those human-supplied contaminants and chemical additives encountered. The pertinent chemistries of ozone are discussed in this paper with respect to the major constituents of pools and spas it is likely to encounter. The numerous technological advantages of ozone generated by corona discharge versus UV radiation also are discussed, including the use of ozone to produce hypobromous acid in situ from bromide ion charged to the pool waters.

Several examples of North American municipal swimming pool installations using ozone according to European teachings are described.

Introduction

In many countries of the world, pool and spa water treatment relies totally on the addition of quantities of chlorine or bromine chemicals for “disinfection”. This means that the halogen compound is added until a specified stable free halogen residual is devel-

oped. Usually it is not recognized that before the stable free halogen residual can be attained, organic and some inorganic contaminants of pool and spa waters must first be oxidized by or otherwise reacted with the halogen “disinfectant”. It is also not recognized that while the halogen “disinfectant” is performing its oxidative work, it is also producing unwanted halogenated organic compounds (i.e., trihalomethanes, haloamino acids, haloamines, etc.). Only after oxidation and halogenation demands have been satisfied, will a measurable free halogen residual be obtained to provide disinfection.

Fact #1: Halogen disinfectants serve first as chemical oxidizing agents, then as halogenating agents, before serving as disinfectants.

Fallacy #1: In pools relying totally on chlorine, chlorine serves only as a disinfectant.

Ozone also can serve, first as a chemical oxidizing agent, then as a disinfectant. It does not produce halogenated organic compounds, unless bromide ion is present in the water being ionized (i.e., sea water, or water to which bromide ion has been added purposely). Therefore, if ozone is used as the chemical oxidizing agent in the initial stages of pool water treatment (and in the appropriate concentrations), much of the halogen-demanding contaminants can be oxidized. Subsequently, not as much halogen will have to be added to provide a stable free residual (halogen) disinfectant concentration in the pool or spa basin.

These statements can be deduced from consideration of the pool contaminants and their known chemistries when treated with strong oxidizing materials which also serve as disinfectants. Before embarking on a discussion of the chemistries of various pool contaminants, however, it will be necessary to discuss some fundamental points concerning the chemistry of ozone itself, which are not generally known in the North American swimming pool water treatment industry.

Journal of the Swimming Pool and Spa Industry

Volume 1, Number 1, pages 25-44

Copyright © 1995 by JSPSI

All rights of reproduction in any form reserved.

The Journal of the Swimming Pool and Spa Industry

Fundamental Parameters of Ozone Technology

Generation of Ozone

In practice, ozone is generated by passage of an oxygen-containing gas through a high energy electrical apparatus (corona discharge) or through a high energy radiation source (UV radiation). For pool and spa water treatment, air is used almost exclusively as the feed gas for either type of generator. Only a portion of the oxygen of the air is converted to ozone by this production technique. Thus, ozone concentrations of 1–4.5% by weight can be obtained by corona discharge techniques. On the other hand, generation by ultraviolet radiation produces much lower ozone concentrations, on the order of 0.1 to 0.001% by weight, about 10 to 1,000 times less than those generated by corona discharge.

Aspects of Ozone Generation By Ultraviolet Radiation

Commercially, there are two types of UV bulbs which have been marketed by UV generators of ozone: those providing mostly 254 nanometer (nm) radiation and those providing mostly 185 nm radiation. Rodriguez and Gagnon (1991) provide an excellent discussion of the differences between these two different wavelength UV bulbs in terms of producing ozone.

Characteristics of 254 nm UV Bulbs: Rodriguez and Gagnon (1991) point out that ca. 89% of the relative spectral energy of a germicidal UV lamp is at 254 nm, with the remaining energy peaking at 290 nm and a low of about 218 nm. Maximum germicidal efficiency of UV radiation occurs at 260–265 nm, at which the UV absorption curve presents a sharp peak. Figure 1 also shows that the maximum destruction of ozone by UV radiation occurs at 254–260 nm, precisely the wavelength of UV energy emitted by this type of UV bulb.

Consequently, it is literally impossible to produce more than traces of ozone when employing 254 nm UV bulbs to “generate ozone”.

Characteristics of 185 nm UV Bulbs: The lower wavelength UV radiation can and does generate small quantities and concentrations of ozone (ca. 0.5 g/h per 425 ma lamp in dry air – Rodriguez and Gagnon 1991). At the same time, however, the produced ozone is photochemically decomposed by the UV radiation, forming hydroxyl free radicals. In aqueous solution, these hydroxyl free radicals (OH•) are stronger oxidizing agents than is molecular ozone (O₃). On the other hand, the half-life of hydroxyl free radicals is on the order of microseconds (compared with minutes for molecular ozone). Consequently, they cannot be ex-

pected to remain in solution for sufficient periods of time to provide adequate disinfection, although considerable chemical oxidation of dissolved organic material can occur.

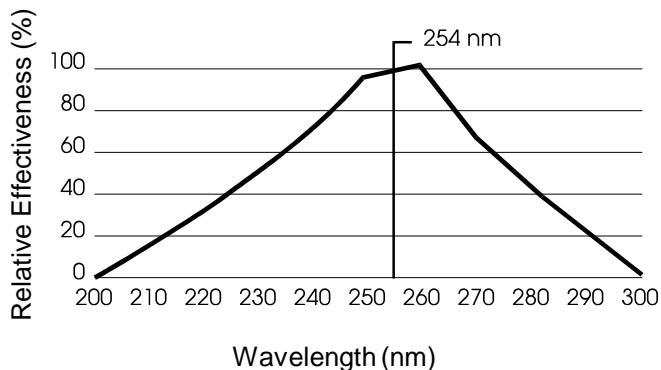

Figure 1. Ozone Destruction Curve by UV Radiation (Rodriguez and Gagnon 1991)

Rodriguez and Gagnon (1991) point out that the generation of ozone by 185 nm UV radiation has been found to reduce total organic carbon (TOC) levels in already high purity waters used in the electronics industry to levels less than 5 ppb (µg/L).

Very recently, new vacuum ultraviolet (VUV) bulbs have been developed which provide UV radiation peaking at 172 nm, and which are capable of producing even higher concentrations of ozone (Eliasson and Kogelschatz 1991). However, as of this writing, these new UV-bulbs have not been described as being commercially available.

The reader can conclude from this discussion that if UV radiation is used to generate ozone, it must be provided by 185 nm bulbs in order to even partially oxidize organic pool/spa contaminants. Even these higher energy bulbs, however, cannot generate more than 0.5 g/h per 425 ma lamp when fed with dry air. If more ozone than this is required, either gangs of 185 nm bulbs must be provided, or else corona discharge ozone generators should be utilized. Hopefully, the newer 172 nm bulbs will become commercially available in the near future.

Aspects of Ozone Generation By Corona Discharge

There are many instructive articles on the corona discharge (CD) generation of ozone and the reader is referred to two of these for the details (Dimitriou 1990; Carlins and Clark 1982). Of primary importance with CD ozone is that the air being fed to the ozone generator must be dried thoroughly; this means to a dew point of at least –60°C, and preferably to –65°C. Appropriately dried air is essential for two reasons:

1. The relative rate of production of ozone decreases rapidly with increasing dew point above -60°C (Figure 2).

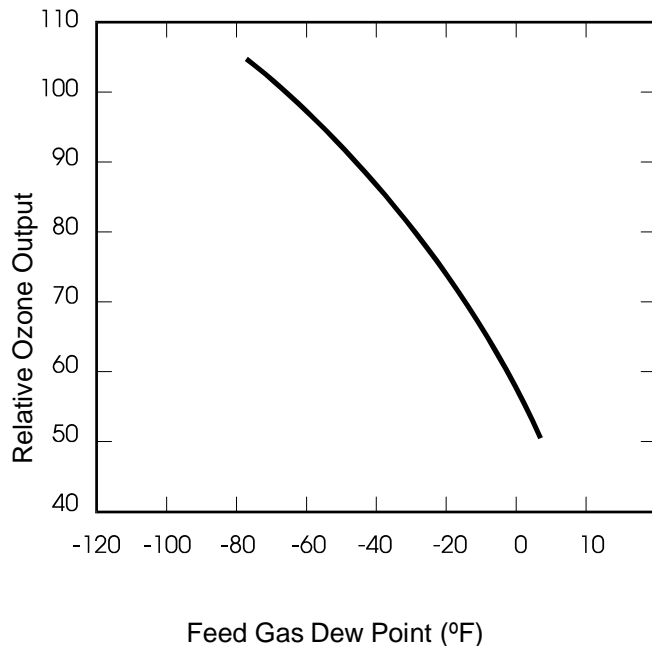

Figure 2. Effects of dewpoint on ozone production (Dimitriou 1990)

2. Small quantities of nitrogen oxides are formed during CD ozone generation. In the presence of atmospheric moisture, the amount of nitrogen oxides increase and form nitric acid, which is quite corrosive to metals and dielectric materials present in the ozone generation apparatus (Masschelein 1982a). The presence of nitric acid will increase the frequency of generator maintenance required.

The overall situation is akin to a “pay me now (for the air drying equipment) or pay me later (for increased maintenance)”.

As pointed out earlier, concentrations of ozone generated in air corona discharge are much higher than those that can be obtained by UV radiation.

FALLACY#2: Ozone generated by UV radiation provides the same work output as ozone generated by corona discharge.

SOLUBILITY OF OZONE IN WATER

Concentrations of ozone in the generator exit gases become very significant when viewed with the knowledge that ozone is only partially soluble in water. The solubility of a partially soluble gas in water is governed by Henry’s law, which states that the

solubility of the gas in water is directly proportional to its partial pressure in the gas phase:

$$Y = H.X$$

in which Y is the concentration (solubility) of ozone in the aqueous phase, X is the partial pressure of ozone in the gas phase, and H is the Henry’s law constant, which can vary with temperature, pH, ionic strength, and other water quality parameters.

Consideration of Henry’s law leads to the obvious conclusion that the higher the concentration of ozone generated, the greater will be the solubility of ozone in the pool or spa water. The reciprocal statement also is true: The lower the concentration of ozone in the gas phase, the lower will be the concentration of ozone in the aqueous phase.

Table I shows the equilibrium solubilities of ozone in water generated by UV radiation and by corona discharge at several water temperatures (Stover et al. 1986). It is clear that when ozone is generated by UV radiation, not as much ozone is available in the water for either oxidation or disinfection.

The word “equilibrium” applied to ozone concentrations is important in this discussion. As ozone is added to water for swimming pool water treatment, the water and ozone-containing gas are mixed together very rapidly, usually under conditions of partial vacuum and high water flow. Consequently, equilibrium conditions never can be attained, or even closely approximated, in operational ozonation systems. Therefore, the solubility data shown in Table I are not, strictly speaking, accurate. Nevertheless, these data illustrate the trends in ozone solubility as consequences of Henry’s law.

Points of Application Of Ozone In Pool/Spa Water Treatment

As a prelude to discussing the details of ozone chemistry in water, it is necessary to understand that CD-generated ozone is added at different points in the municipal pool or spa water treatment process than is ozone generated by UV radiation. In public pools and spas, which require free residual halogen in the pool basin, CD-generated ozone generally should be added early in the treatment process, just before or just after the filter (preferably, just before), and before makeup halogen is added. In North America, UV-generated ozone is added after all other treatment steps, after the required halogen level has been attained, and as the treated water enters the pool or spa. This means that the chemical nature of the contaminants present in the water will be different, particularly with respect to residual halogen levels, at the point(s) of ozone addition generated by the two techniques.

Temperature °C	Gas Phase Ozone Concentration (% by weight)					
	0.001% UV-254 nm	0.1% UV-185 nm	1% CD	1.5% CD	2% CD	3% CD
	Equilibrium Ozone Water Solubility, mg/L					
5°	0.007	0.74	7.39	11.09	14.79	22.18
25°	0.004	0.35	3.53	5.29	7.05	10.58
30°	0.003	0.27	2.70	4.04	5.39	8.09

Table I. Solubility of Ozone in Water (in mg/L) as Generated by UV Radiation and Corona Discharge (Stover et al, 1986)

WATER TREATMENT BY UV-GENERATED OZONE

In North America, low concentrations of ozone generated by ultraviolet radiation are added to the treated water as shown in Figure 3. In public swimming pools and spas, a residual of free chlorine or free bromine is required; this requirement is satisfied prior to the addition of UV-generated ozone. Residential pools and spas are not required to maintain a free residual halogen concentration (although such residuals can be beneficial), and in many residential spas, ozone is used as the sole oxidation and disinfection agent. In these circumstances, UV-generated ozone still is being added at the end of the water treatment process.

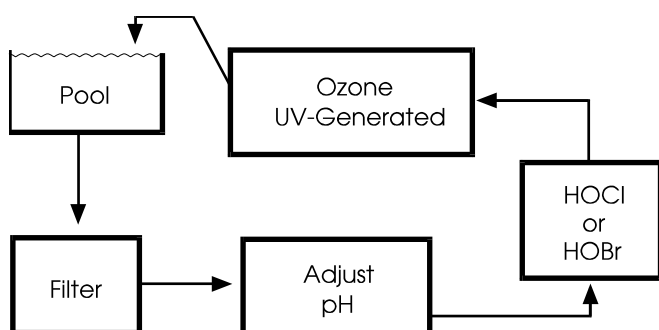

Figure 3. Schematic diagram of pool/spa water treatment process involving UV-generated ozone.

WATER TREATMENT BY CD-GENERATED OZONE

In literally thousands of European public, semi-public, and residential pools and spa, ozone generated by corona discharge is used as the primary oxidizing agent early in the water treatment process and prior to addition of makeup chlorine. Because of the higher concentrations of ozone produced by corona discharge, CD generated ozone can be used to oxidize most of the

impurities present in pool and spa waters, thus minimizing the later formation of chlorinated compounds.

Two major water treatment processes employing ozone are in use to treat swimming pools and spas in Germany. These will be described briefly to set the stage for more detailed discussions of the chemistries of ozone in pool and spa waters.

The German DIN Standard Process

The most comprehensive European pool water treatment standard is described in German DIN Standard 19,643, which first appeared as the German “KOK Guidelines” in June 1972. These Guidelines were adopted formally as the current DIN Standard in 1982, and since then it has also been adopted *in toto* in Switzerland, Austria, and The Netherlands. The British and French, while not adopting the German DIN standard *in toto*, nevertheless have integrated many of its precepts into their pool and spa water treatment regulations, particularly with respect to the use of ozone.

DIN Standard 19,643 itself is entitled, “Treatment and Disinfection of the Water of Swimming Pools and Baths”. In it, regulations are presented for all aspects of water treatment relating to swimming pools and baths, including flocculation, ozonation, activated carbon treatment, chlorination, etc. At the present time, four specific treatment processes are approved in this standard, only one of which employs ozone. However, the same quality of treated water is required, regardless of which of the four approved processes is used.

One of the first precepts of DIN standard 19,643 is that water quality entering the pool (treated and makeup waters) shall meet drinking water standards. In Germany today, this means that the maximum levels of trihalomethanes (THMs) in the pool water must be 35 ug/L or less (current U.S. standard is 100 ug/L).

Figure 4 illustrates the DIN Standard process which involves the use of ozone. The block labelled "TREATMENT" in Figure 4 is expanded in Figure 5, to show each discrete treatment step. This standard requires that the minimum concentration of ozone generated be 18 g/m³ (1.5% by weight; 18,000 ppm). Such a requirement automatically rules out UV-radiation for generating ozone. By the same token, CD ozone generators which do not dry the feed gas air also are ruled out, because without drying of the air, the required concentration of ozone cannot be generated consistently.

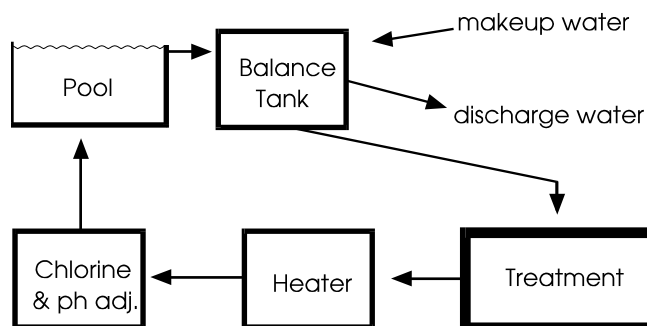

Figure 4. Schematic diagram of German DIN standard treatment process using ozone (Part #1).

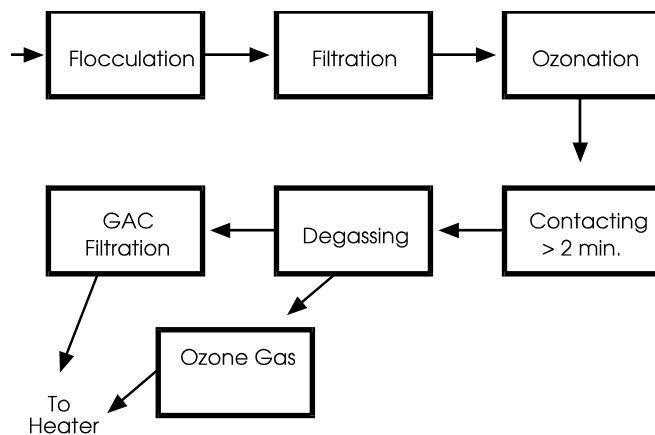

Figure 5. Schematic diagram of German DIN standard treatment process using ozone (Part #2).

The basic water treatment process incorporates the following steps:

- Treated water enters the bottom of the pool basin and flows upward, overflowing into a balance tank.
- From the balance tank, some water is discharged continuously to waste (ca. 30-L/bather); this is counter-balanced by continuous addition of an equal volume of fresh makeup water. The volumes of water discharged and makeup water added are determined by the bather load (the "b" factor).

- From the balance tank, diluted pool exit water is treated by chemical flocculation;
- Sand or dual media filtration;
- Ozonation (1 to 1.2 mg/L dosage; 1.5% by weight minimum concentration; 2+ minutes reaction time);
- Granular activated carbon (GAC) filtration (to remove additional insoluble materials and destroy residual ozone);
- pH Adjustment by addition of mineral acid or CO₂;
- Chlorination (to a minimum free residual of 0.2 and a maximum residual of 0.5 mg/L).
- Treated water is sent to the pool inlets.

Chlorine is the only disinfectant allowed in German public swimming pool water, without special exception (to allow the use of bromine generated from bromide ion by ozone – see next section). Ozone must be absent in the pool basin waters so as to avoid the possibility of bathers breathing ozone escaping to the atmosphere and settling above the pool surface. In addition, pool water must meet German drinking water standards, which include a turbidity level not to exceed 0.2 NTU in the treated water reentering the pool basin, and not to exceed 0.5 NTU in the pool basin itself.

The Ozone – Bromide Ion Process (The Bromofloc Process)

A recent improvement of the older ozone/bromide ion process has been shown to be able to meet the stringent water quality requirements of the DIN Standard process. Its predecessor ozone/bromide ion process is in use in at least 300 German public swimming pools, spas, therapy baths, and residential pools and spas, and in at least two residential pools/spas in the United States. Water qualities equal to those of the DIN Standard approved processes are obtained by this process, which involves the use of free bromine as the pool disinfectant, rather than free chlorine.

By the original ozone/bromide ion process, which did not include flocculation, all DIN water quality requirements were met, except that total THMs (primarily bromoform) exceeded 100 ug/L. Inclusion of flocculation with ozonation and increasing the ORP level to a minimum of 800 mV leads to reduction of total THMs to below 10 ug/L (Pacik and Rice 1991).

The principles of the ozone/bromide ion (Bromofloc) process are illustrated schematically in Figure 6. In the balance tank, bromide ion (sodium bromide*) is charged to an initial concentration of

*NaBr (in conjunction with ozone) is not yet approved by the U.S. EPA for use in commercial swimming pools.

about 15 mg/L. From the balance tank, the water is treated by flocculation, then ozonation (same levels as required by DIN 19,643), and filtration.

In addition to oxidizing pool contaminants, ozone also oxidizes bromide ion to form hypobromite ion/hypobromous acid. This oxidation of bromide ion is so rapid that the half life of residual ozone in the presence of excess bromide ion is on the order of 5.6 seconds (Haag and Hoigné 1984). Consequently, the excess bromide ion serves to destroy excess ozone while forming more hypobromous acid. This means that GAC is not necessary to destroy ozone with this process, and no residual ozone can survive to the pool basin.

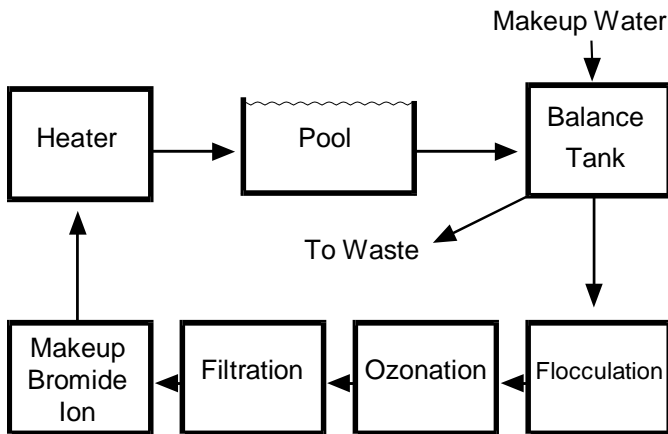

Figure 6. Schematic diagram of pool water treatment with ozone and bromine (Pacik & Rice 1991).

Ozone As The Sole Pool/Spa Disinfectant

Although no longer widely practiced as a treatment concept in European public pools and spas, ozone can be used as the sole disinfectant, provided that the pool hydraulics are very good (to assure the presence of ozone residual at all points in the pool basin) and provided that the ozone residual is low enough to insure that no noticeable concentrations of ozone will be present above the pool waters. Swiss swimming pool regulations still allow ozone as the sole disinfectant in existing older pools, provided that its concentration in the pool influent does not exceed 0.02 mg/L. However, new Swiss public pools and spas must conform with the German DIN Standard requirements.

In these systems (Figure 7), ozone is added after the balance tank, prior to filtration. There is no chemical flocculation (low bather loads) and no GAC filter to destroy excess ozone. Instead, a redox potential (oxidation reduction potential – ORP) monitor/controller regulates the output of the ozone generator to assure an ozone dosage adequate to provide both oxidation and disinfection, but not wasteful excesses, which can pose a breathing hazard to the users.

In the event that residential pool hydraulics are not sufficient to allow ozone as the sole oxidant/disinfectant, it is common European practice to add sodium bromide to the water and operate the ozone/bromide ion process. This guarantees a disinfecting residual of free bromine [HOBr/(OBr-)] throughout the pool water.

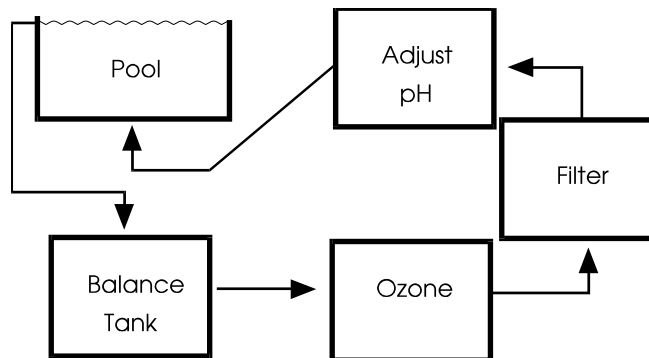

Figure 7. Schematic diagram of residential pool treated with ozone alone.

Chemistry Of Ozone In Water

REACTIONS OF OZONE IN WATERS FREE OF CONTAMINANTS

In clean water (fresh waters influent to the pools or spas), the major factors which affect the chemistry of ozone are:

- solubility
- decomposition rate of ozone,
- pH,
- temperature, and
- the transfer efficiency of gaseous ozone into water.

These five factors also will affect the chemistry of ozone in contaminated pool and spa waters, with the added factor of reaction of ozone with contaminants added by bathers.

Solubility of Ozone in Water

Oxidation or disinfection benefits attained by ozone are dependent upon the amount of ozone transferred to the pool or spa water during contacting. The solubility of ozone in water is a function of the partial pressure of ozone in the air above the water, which is determined by the partial pressure (concentration) or ozone in the air (Henry's law, as discussed earlier). When ozone is generated from properly dried air by corona discharge techniques, the concentration of ozone in the air exiting the ozone generator is approximately

1.5% to 4.5% by weight (18,000 to 54,000 ppm).

When ozone is generated from air by UV radiation, the concentrations of ozone in the gases exiting the generator are much lower than by corona discharge, on the order of 0.1% by weight (1.2 g/m³; 1,200 ppm-vol) to 0.001% by weight (0.012 g/m³; 12 ppm-vol). At such low concentrations, the corresponding concentrations of ozone which can be obtained in water are much lower than those attainable by CD generation.

As a consequence of these principles of ozone solubility, the German DIN Standard (19,643) specifies that when ozone is employed for treating public swimming pools, the ozone generator(s) must produce a minimum ozone concentration of 18 g/m³ (1.5% by weight; 18,000 ppm). This requirement eliminates UV radiation as an ozone-generating procedure.

FALLACY #2 (reprise): Ozone generated by UV radiation is as effective as ozone generated by corona discharge.

Decomposition of Ozone in Water

Over the past 15 years, Hoigné and his coworkers have defined the decomposition products of ozone in water, in the absence and presence of inorganic and organic materials with which ozone reacts. A recent summation is recommended for the specific details (Hoigné 1988).

When dissolved in water, ozone can react with water contaminants by two mechanisms: by direct reaction as the O₃ molecule, and by indirect (hydroxyl) free radical reactions. In strongly acid solutions, the direct reaction predominates, but above pH 7 radical reactions predominate in addition to direct reactions. Species which are produced when ozone is present in water above pH 7, include the following:

Hydroxyl free radicals	(OH)•
Hydroxide ions	(OH) ⁻
Perhydroxide ions	(HO ₂ ⁻)(the anion of H ₂ O ₂)
Perhydroxyl free radicals	(HO ₂)•
Superoxide anions	O ₂ ⁻
Ozonide anions	O ₃ ⁻

Of these species, the most reactive is the hydroxyl free radical, having an oxidation potential higher than that of the ozone molecule itself. Therefore its presence is desirable for the oxidation of swimming pool and spa water contaminants. Many of the anions listed participate in chain reactions which produce hydroxyl free radicals ultimately.

Effects of pH

In typical, natural, clean, raw drinking waters at pH about 8, approximately half of the ozone introduced is decomposed within about 10 minutes, producing hydroxyl free radicals (Hoigné and Bader 1979). Since swimming pool and spa waters normally are maintained at pH levels between 7.2 and 8.0, it can be concluded that upon addition of ozone to the water, both the O₃ molecule and hydroxyl free radicals will be present to perform oxidation and disinfection work in the water. However, only the ozone molecule (O₃) is capable of disinfection, because of the very short (microsecond) half-life of hydroxyl free-radicals.

Effects of Temperature

It is a well-known kinetic rule-of-thumb that as temperature increases, the solubilities of gases in solution decrease. At the same time, however, reaction rates increase, in general doubling for each 10°C rise in temperature. Perusal of the solubility data for ozone given in Table I shows that the solubility of ozone in water indeed decreases from 0°C to 30°C, and thus ozone behaves normally with respect to the solubility rule-of-thumb. At 30°C the solubility of ozone generated by corona discharge still is quite sufficient to provide the desired amount of oxidation and/or disinfection. Also at this temperature, decomposition of dissolved ozone to produce hydroxyl free radicals and reactions of these radicals and molecular ozone with pool water contaminants will be much faster than the same reactions at lower temperatures.

Transfer Efficiency of Gaseous Ozone Into Water

From these discussions, it should be clear that if the efficiency of transfer of ozone into the water is poor, not as much ozone will be present in the water to accomplish the desired work (oxidation and/or disinfection). Therefore in designing ozonation systems, it is important to employ efficient gas/liquid contacting. Fortunately, swimming pool and spa waters are circulated at fairly rapid rates by means of pumps. Advantage is taken of this rapid water circulating to design Venturi-type injector contactors into the flowing system. As water flows through this type of device, a partial vacuum is produced in a standpipe which can be connected to the ozone generator. This partial vacuum draws the ozone-containing gas into the Venturi injector, where if adequate flow velocity and therefore adequate mixing is present, the transfer efficiency of ozone can be almost total.

On the other hand, if the rate of water flow through the Venturi-type injector is insufficient to produce enough vacuum to provide good mixing, then much of the ozone-containing gas will not be mixed

well with the water, and the ozone transfer efficiency will be very low. To insure proper mixing, some CD–ozone equipment suppliers also provide booster pumps which increase the rate of flow of at least a portion of the recycling pool/spa water (sometimes all of it) to produce higher partial vacua and greater mixing efficiencies.

French treatment of public swimming pool waters currently involves flocculation, filtration, then ozone disinfection of treated water. For ozone disinfection, French public health officials specify that an ozone residual concentration of 0.4 mg/L must be maintained for a minimum contact time of four minutes. These requirements normally are attained in two contact chambers, operating at ambient pressure, each having a 4–6 minute contact time.

In this instance, French pool designers find it cost-effective to take the ozonation step out of the direct water flow stream, and add the ozone through diffuser contactors of the type normally employed in municipal drinking water treatment plants for ozonation. The contact chambers are maintained at atmospheric pressure, while the ozone-containing gas, under about 15 psig pressure from the ozone generator, is bubbled through the diffusers.

In such cases, the factors affecting transfer efficiency of ozone into the water include the size of bubbles, depth of the contact chambers (both of these factors determine the rate of rise of gas bubbles containing ozone and air), and concentration of ozone in the gas phase.

For a masterful discussion of the various types of ozone contactors which are available, the reader is referred to Masschelein (1982b).

Destruction of Ozone by Granular Activated Carbon (GAC)

In European pool and spa water treatment systems which incorporate CD ozone and residual chlorine in the pool/spa basin, the ozonized water is degassed to liberate as much air/ozone gases as possible from the water. Ozone remaining in the gas and liquid phases is destroyed by passage through GAC. This material is elemental carbon, which is a strong reducing agent. Upon contacting ozone, the carbon is oxidized to carbon monoxide and carbon dioxide. Simultaneously, the ozone molecule is destroyed:

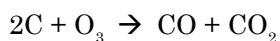

In some instances, it is possible that all of the ozone can be converted to CO_2 by the activated carbon:

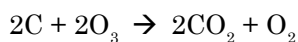

REACTIONS OF OZONE IN CONTAMINATED POOL AND SPA WATERS

Pool Water Contaminants Treatable With Ozone

When pools and spa are used by human beings, many varied types of pollutants are brought into the water. Outdoor pools are contaminated with animal and vegetative debris, pollen, and airborne microorganisms, as well as materials washed off of and excreted from human bodies. These added contaminants can be classified broadly as organic, microbiological, and inorganic.

Organic contaminants include perspiration, urine, secretions (nasal, pharyngic), body creams and ointments, and cosmetic products. Some of the organic components which are difficult to treat include urea and amino acids (such as creatinine). Microbiological contaminants include bacteria, viruses, fungi, yeasts, amoebae, and cysts; inorganic contaminants include ammonia, chlorine (free and combined), and bromine (free, combined, and bromide ion). When the raw water is natural groundwater from wells, contaminants also may include soluble iron, manganese, and sulfide ions as well.

Ozone Reactions With Organic Compounds

Although there are a few organic compounds which are rapidly oxidized by ozone to destruction (i.e., formic acid, phenol), the great majority of organic compounds are only partially oxidized, even by as strong an oxidizing agent as ozone, in aqueous solutions, particularly under the conditions which exist in swimming pool and spa water. Most organic compounds, particularly those which are refractory in nature (i.e., organo–nitrogen compounds – urea, creatinine; organo–chlorine compounds – chlorisocyanurates, trihalomethanes), are only slightly reactive with ozone, and are not destroyed by ozonation, except upon greatly extended reaction times (up to hours), which are not practical in pool and spa water treatment.

FALLACY #3 Ozone will oxidize all pool and spa organic materials totally to carbon dioxide and water.

One of the major advantages of partial oxidation of organic materials present in pool/spa waters by ozone is that in becoming partially oxidized, the organic materials become much more polar than they were originally. Polar groupings such as carbonyl

(>C=O), carboxyl (-COOH), and hydroxyl (-OH) groups are formed in the carbonaceous structures by oxidation. In the presence of polyvalent cations (i.e., calcium, magnesium, iron, aluminum, manganese), these polar groupings can combine with the polyvalent cations to produce complexed materials which are higher in molecular weight, thus becoming insoluble, and which can be removed readily by filtration. This type of process is called "microflocculation" (flocculation of soluble micropollutants), and has been described in detail by Maier (1984).

Most of the information available today on the reactions of organic compounds with the strong oxidizing agents used or found in pool/spa waters (ozone, chlorine, bromine, and chloramine) comes from studies conducted in the drinking water treatment field. For details, the reader is referred to several review articles (Miller et al. 1978; Gilbert 1979; Rice and Gomez-Taylor 1986).

In Germany, the Technical University of Munich maintains an Institute of Water Chemistry and Chemical Balneology. At this research institute is a full-sized swimming pool designed to study the chemical effects of various water treatments on pool water qualities (Eichelsdörfer and Quentin 1982). From this institute, many studies dealing with the use of ozone in pool water treatment have been reported in the pool/spa scientific literature. Among other experimental results, the Munich scientists have shown that urea is only slowly reactive with ozone (Eichelsdörfer and von Harpe 1970), requiring some five hours for complete destruction. Other Munich studies (Eichelsdörfer and Jandik 1985) have shown that the cyclic amino acid creatinine requires 25 minutes to be totally eliminated from pool water by ozonation when ozone is present in a concentration 2.5 times higher than that of the creatinine (Figure 8, which also shows the slow reduction in TOC concentrations during ozonation).

On the other hand, when the amino acids and urea are treated with chlorine, the corresponding N-chloro-derivatives are produced. In turn, the N-chloro compounds are much more susceptible to ozone oxidation than are the non-chlorinated nitrogen-containing compounds. Consequently, the presence of free residual chlorine (or bromine) in the pool/spa basin will form N-halo-derivatives which are easier to oxidize with ozone.

FACT #2: The presence of a small residual halogen level in the pool or spa basin assists the removal/destruction of organo-nitrogen contaminants during CD-ozone treatment.

To summarize this subsection, many of the organic contaminants in pool and spa waters, which are indicated as a group parameter, such as TOC (total organic carbon), react very slowly with ozone. For the most part, only the average oxidation states or mo-

lecular structures of the mixture of organic substances are changed, with no substantial reduction in the level of organically combined carbon (TOC). Oxidation to carbon dioxide takes place only slowly, if at all.

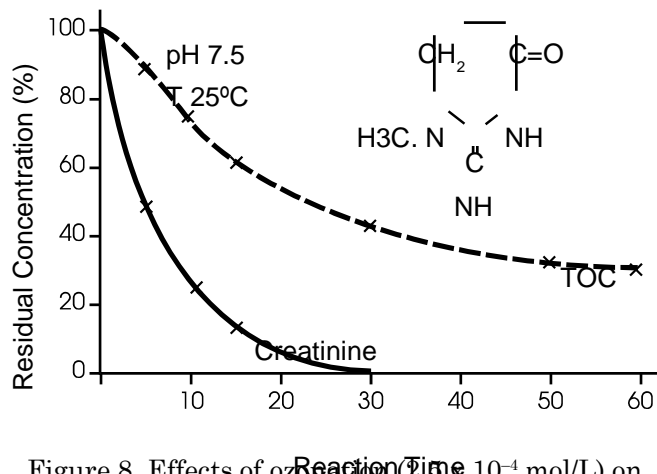

Figure 8. Effects of ozonation (Ozone 10⁻⁴ mol/L) on concentrations of creatinine (10⁻⁴ mol/L) and TOC (Eichelsdörfer & Jandik 1985).

Consequently, European pool/spa water treatment relies on combinations of treatment steps, involving more than one processing step for removal of water contaminants, i.e., flocculation, oxidation, GAC filtration, etc., to produce high quality pool and spa waters.

FALLACY #4: Ozone alone can remove all contaminants from pool and spa waters.

Ozone Reactions With Microbiological Contaminants (Disinfection)

These contaminants include bacteria, viruses, fungi, amoebae, and cysts, all of which can be destroyed or inactivated by ozone, although different ozonation conditions are necessary for each species. Cyst organisms are the most resistant to all disinfectants, because of their protective shells. The extent of inactivation or destruction of microorganisms is related to the product of the concentration of disinfectant (C, in mg/L) times the contact time (T, in minutes). The product of these two parameters is called the "CT Value", expressed in units of mg/L-min:

$$C \times T = \text{CT Value}$$

As discussed earlier, the concentration of ozone in the gas phase controls the solubility (and therefore the concentration) of ozone in solution.

In June 1989, the U.S. Environmental Protection Agency (U.S. EPA) promulgated new regulations for the disinfection of drinking water which incorpo-

rate the concepts of CT values (U.S. EPA 1989). In these regulations, EPA has defined a CT value for each disinfectant used in treating drinking water (chlorine, ozone, chlorine dioxide), over the pH range 6–9, and for water temperatures from 0.5°C to 25°C. The higher the water temperature, the lower is the CT value required to provide the amount of disinfection required by EPA’s new disinfection regulations. Many of the specific organisms being regulated by EPA in drinking water are the same as those which are found in swimming pool and spa waters (i.e., *Giardia* cysts, enteric viruses, *Legionella* bacteria, fecal coliforms, and heterotrophic plate count organisms).

For disinfection with ozone, EPA recommends attaining a maximum CT value of 2.9 mg/L–min at <1°C decreasing to 0.48 mg/L–min at >25°C. Attaining these specified CT values with ozone will guarantee the inactivation of 99.9% (3–logs) of *Giardia* cysts, and, simultaneously, the inactivation of greater than 99.999% (5–logs) of enteric viruses. When these levels of inactivation of *Giardia* cysts and enteric viruses are attained, total destruction of *Legionella* organisms, *E. coli*, and heterotrophic plate count organisms also is assured.

Table II lists the CT values currently recommended by the U.S. EPA for obtaining varying logarithms of inactivation of *Giardia lamblia* cysts with ozone at varying temperatures. When even 0.5–log of inactivation of *Giardia* cysts is obtained with ozone, more than 5–logs of inactivation of enteric viruses will be obtained, along with total bacterial kills. Consideration of ozone solubility data (Table I) with CT values given in Table II confirms the expectations of being able to disinfect microorganisms usually found in swimming pools and spas with ozone generated by corona discharge, but not with ozone generated by UV radiation.

When ozone is generated by corona discharge techniques for use in pools and spas (at concentrations

≥ 1.5% by weight) and applied in the European recommended dosages (minimum 1 mg/L for swimming pools and 1.3 mg/L for spas), the dissolved ozone concentrations of ozone will reach 0.3 to 0.5 mg/L readily. Holding these dissolved ozone levels for 2+ minutes will provide CT values of 0.6+ to 1.0+ mg/L–min, easily sufficient to provide all of the disinfection required by EPA’s new drinking water regulations at 25°C water temperatures.

By contrast, the necessary concentrations of dissolved ozone simply cannot be attained using ozone generated by ultraviolet radiation, because the concentrations of ozone in the generator exit gases are too low. Corona discharge generators, fed with adequately dried air, are the only practical types of ozone generator currently available which can provide the necessary ozone concentrations required to guarantee destruction of all microbiological species present in pool and spa waters.

FACT #3: Application of ozone generated in proper concentrations, by corona discharge, in proper dosages, and with sufficient reaction times, will provide adequate disinfection as well as chemical oxidation.

FALLACY #5: UV-generated ozone will provide disinfection equivalent to that provided by CD-generated ozone.

Reactions of Ozone With Inorganic Contaminants

These contaminants include ammonia, free chlorine [hypochlorous acid (HOCl) and hypochlorite ion (OCl)⁻], monochloramine, ClNH₂, and free bromine [hypobromous acid (HOBr), hypobromite ion (OBr)⁻] and bromide ion, Br⁻. When the raw water is natural groundwater from wells, contaminants also may include soluble iron, manganese, and sulfide ions.

Reaction of Ozone With Ammonia: At the pH

Logs of Inactivation	Temperature, °C					
	< 1	5	10	15	20	25
0.5 log	0.48	0.32	0.23	0.16	0.12	0.08
1 log	0.97	0.63	0.48	0.32	0.24	0.16
1.5 logs	1.5	0.95	0.72	0.48	0.36	0.24
2 logs	1.9	1.3	0.95	0.63	0.48	0.32
2.5 logs	2.4	1.6	1.2	0.79	0.60	0.40
3 logs	2.9	1.9	1.43	0.95	0.72	0.48

TABLE II. CT values for inactivation of *Giardia* cysts by ozone
U.S. EPA, 1989b

ranges normally encountered in swimming pools and spas (7.0–8.0), reaction of ammonia with ozone is so slow as to be insignificant. Only when the pH is elevated to above 9.0, does ozone oxidize ammonia at a reasonable rate (Singer and Zilli 1975).

FALLACY #6: Ozone will oxidize ammonia in swimming pool waters.

Reactions of Ozone With Chlorine Species:

In pool/spa waters in the pH range of 7.2 to 8.0, free chlorine is present as both hypochlorous acid (HOCl) and hypochlorite ion [(OCl)⁻]. Haag and Hoigné (1984) have shown that ozone added to waters containing these species will not react with HOCl, but will react with hypochlorite ion at a reasonable rate, producing 77% chloride ion and 23% chlorate ion:

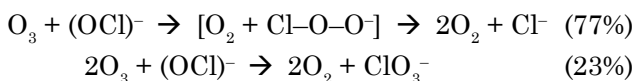

overall:

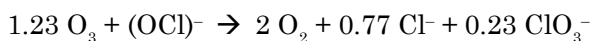

Second order rate constants were measured for the loss of ozone and of hypochlorite ion (OCl)⁻ by this equation (Haag and Hoigné 1984) and found to be 120 M⁻¹s⁻¹ and 98 M⁻¹s⁻¹, respectively, at 20°C. This means that if the concentration of free chlorine is assumed to be essentially constant at 2.0 mg/L, as would be the case in chlorinated spa waters to which UV-generated ozone is added, the half-life of ozone loss by reaction with hypochlorite ion is 15 minutes at pH 7 and 4 minutes at pH 9 (Haag and Hoigné 1984). In pool waters at pH 7.5 containing 1 mg/L of free chlorine, the half-life of ozone has been shown to be five minutes (Hoigné 1985). At the elevated temperature in pools and spas, the half-lives of ozone in the presence of hypochlorite ion will be even shorter.

Although the undissociated form of free chlorine, HOCl, does not react with ozone, it should be realized that in the pH range of pool/spa waters (ideally 7.2–7.8), HOCl is in equilibrium with (OCl)⁻ (pKa = 7.5 – e.g., at pH 7.5, hypochlorous acid and hypochlorite ion are in equal concentrations). Therefore, as pool waters are ozonized and hypochlorite ion is oxidized, hypochlorous acid dissociates to produce more hypochlorite ion. Thus, if the reaction is allowed to continue long enough with sufficient concentrations of ozone being applied, all of the chlorine present will be converted to chloride and chlorate ions, assuming that during the oxidation, no additional chlorine is added.

In swimming pool and spa waters which are disinfected with chlorine chemicals, however, chlo-

rine is added continuously to maintain a minimum level. Therefore, there may always be an excess of free chlorine over ozone. Consequently, much of the ozone added can be expected to be destroyed by reaction with hypochlorite ion. This will be especially true with ozone generated by UV radiation, where very low quantities of ozone at very low concentration are added to pool/spa waters after the free chlorine level has been adjusted to high levels relative to those of the added UV-generated ozone.

By contrast, in pool or spa waters treated with ozone according to the German DIN standard process, low levels of free chlorine are present (0.2 – 0.5 mg/L) as the water enters the pool. Part of the pool exit water is discharged to waste and an equivalent amount of fresh water is added, thus diluting the level of free chlorine. Flocculant is added, followed by filtration, during which the chlorine level is lowered even further.

Ozone is added next, at an applied dosage of 1 mg/L at a concentration in the CD generator exit gas of at least 18 g/m³. This means that in the ozone reaction chamber, ozone can be present in water at a constant concentration range of 0.2 to 0.5 mg/L (see Table I for data on the solubility of ozone at 30° to 25°C), which is close to the maximum concentration of free chlorine (<0.5 mg/L). Under these conditions, the half-life of the free chlorine calculated by Haag and Hoigné (1984) ranges from 50 minutes at pH 7 to 15 minutes at pH 8. Since the reaction time of ozone is on the order of two–three minutes, after which the water is degassed and the water deozonized by passage through GAC, very little of the free chlorine present in the contact chamber is lost by oxidation with CD-generated ozone.

FACT #4: Adding UV-generated ozone to pool/spa water as it enters the pool with residual chlorine cannot possibly provide sufficient dissolved ozone for a sufficient period of time to provide disinfection or oxidation of organic contaminants.

Reactions of Ozone With Monochloramine:

Haag and Hoigné (1984) also have shown that ozone slowly oxidizes monochloramine to produce nitrate and chloride ions according to the following equation:

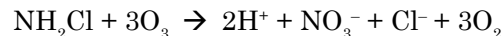

The rate constant for ozone consumption was found to be 26 M⁻¹s⁻¹ at 20°C, while that for NH₂Cl loss was 6 M⁻¹s⁻¹. These rates are much slower than those for the oxidation of hypochlorite ion by ozone. However, in the case of recycling spa or pool water containing combined chlorine (monochloramine) being treated with ozone, a constant, slow oxidation of the combined chlorine to form chloride and nitrate ions can be

expected. Based on the reaction rate constants and high concentrations of dissolved ozone in water, more destruction of chloramine will occur by addition of ozone generated by corona discharge than by UV radiation.

FALLACY #7: UV-generated ozone will destroy chloramines.

Reactions of Ozone With Bromine Species:

As described earlier, one water treatment process currently used in German public and private pools and spas involves the use of ozone as the oxidizing agent, chemical flocculation, and bromide ion (the Bromofloc process, see Figure 6). During treatment, ozone is added to pool water after the balance tank, before filtration and in conjunction with chemical flocculation. At this point, water is disinfected, organics are partially oxidized, and, most important, bromide ion is oxidized to produce free bromine [HOBr + OBr⁻]. Additional bromide ion is added to the balance tank makeup water in the form of NaBr solution and/or HBr (hydrobromic acid), which also serves to adjust the pH, or after filtration.

From a basic chemistry point of view, this ozone/bromide ion system is analogous to the well-known sodium bromide/persulfate procedure, in which bromide ion is oxidized to hypobromite ion by the persulfate material (Mitchell 1985).

The chemistry involved with the ozone/bromide process is as follows (Haag and Hoigné 1983):

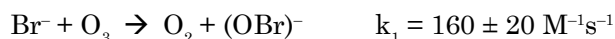

In aqueous solution, the hypobromite ion forms hypobromous acid:

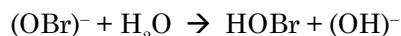

and an equilibrium is set up between hypobromous acid and hypobromite ion:

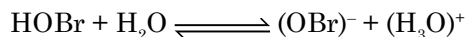

In the pH range of 7.2 to 8.0, this equilibrium (pKa = 8.8) lies primarily to the left, e.g., most of the bromine is present as hypobromous acid.

When hypobromous acid disinfects microorganisms or oxidizes organic or inorganic pollutants, the bromine atom is reduced to bromide ion, which then becomes available again to be reoxidized by ozone to hypobromite ion again:

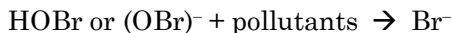

The above chemistry is complicated somewhat by the oxidation of hypobromite ion by ozone to produce bromide ion (77%) and bromate ion (23%) according to the following equations (Haag and Hoigné 1983, 1984):

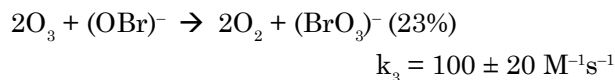
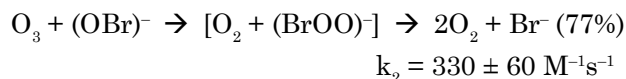

Notice that the ratio of bromide to bromate ions formed is the same as the ratio of chloride to chlorate ions formed in the chlorine system, and also that the reaction rate to produce bromide ion is over three times faster than the reaction to produce bromate ion. Moreover, the reaction proceeds predominantly via the dissociated form (hypobromite ion), as with the chlorine system. On the other hand, ozone will not oxidize chloride ion to HOCl, as it will oxidize bromide ion.

Figure 9 summarizes the various stages in the ozone oxidation of bromide ion (Haag and Hoigné 1983, 1984). It should be appreciated that chlorine also oxidizes bromide ion, producing hypobromous acid/hypobromite ion by much the same mechanisms.

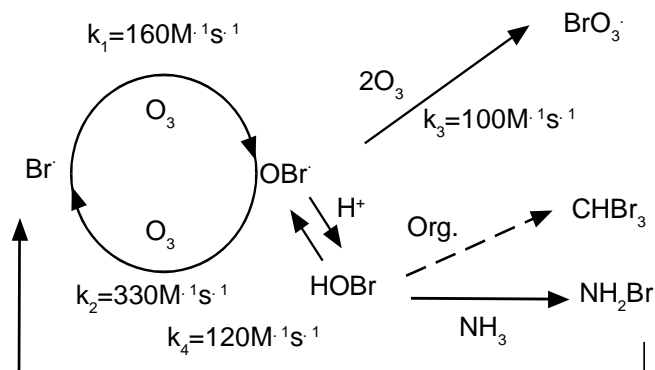

Figure 9. Oxidation of bromide ion by ozone (Haag and Hoigné, 1983 1984).

In treating pool and spa waters, suppliers of bromine (or chlorine) disinfectants recommend that the pH be maintained in the range of 7.2 to 8.0. In this pH range, the amount of hypobromite ion present is much lower than the corresponding amount of hypochlorite ion present with the chlorine system (see Table III).

Consequently, more chlorine disinfectant will be

Bromine		pH	Chlorine	
% as (OBr ⁻)	% as HOBr		% as HOCl	% as (OCl ⁻)
4	96	7.2	66	34
6	94	7.5	48	52
13	87	7.8	33	67
17	83	8.0	22	78

TABLE III. Comparison of percentages of active halogen forms (Mitchell, 1985)

lost to ozone oxidation of the hypochlorite ion (conversion to chloride ion which is not reoxidized by ozone) than will bromine disinfectant. That amount of hypobromite ion which is converted to bromide ion by ozone oxidation will reform HOBr upon continued ozone oxidation.

In pool and/or spa waters disinfected with bromine species, ammonia, urea, and amino acids also will be present. These will form bromamine derivatives, as will the corresponding chlorine species. Monobromamine reacts rapidly with ozone to produce nitrate and bromide ions (Hoigné 1985):

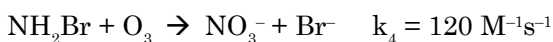

This reaction rate is nearly five times the corresponding rate of ozone oxidation of monochloramine.

Since ammonia does not react with ozone in the pH range 7.2 to 8.0, use of the ozone/bromide ion system provides a convenient method for chemically removing ammonia from recycling pool and spa waters. It is quite likely that bromamine derivatives of urea and creatinine also will be destroyed slowly by ozonation in similar fashion, analogous to the corresponding reactions with the ozone/chlorine systems.

Because bromo-chloro-dimethylhydantoin (BCDMH) is approved by the U.S. EPA and sodium bromide is not yet approved, there is a tendency in the U.S. to employ BCDMH as the source of bromide ion in conjunction with corona discharge ozonation of pools and spas. In this case, however, several additional points should be observed:

1. Bromide ion will be oxidized both by chlorine (present as a result of BCDMH) as well as by ozone, and in approximate stoichiometric ratio of their concentrations;
2. Some ozone and some hypochlorite anion (as a consequence of addition of BCDMH) will react with each other, to their mutual destruction;

3. Some ozone **may** react with the organic moiety in the BCDMH (although one of its suppliers claims this is not the case);
4. There may be a tendency to decrease the amount of ozone added (to reduce ozone costs) since chlorine will be present from the BCDMH to oxidize bromide ion anyway. This last point carries the following additional negative ramifications:

Since the primary objective of adding ozone to circulating pool and/or spa water is to oxidize the contaminants added by bathers as much as possible, any diminution in the amount of ozone added will defeat this objective. Furthermore, as has been shown by Barlow (1993), when the bromide ion concentration reaches a level of about 50 mg/L (recall that the German experience is to provide 15 mg/L of bromide ion), the added ozone will produce more and more free bromine [HOBr/(OBr)⁻] and oxidize fewer and fewer organic contaminants. This result is due to the facts that (a) the bromide ion concentration now is much higher with respect to that of the organic contaminants and (b) the rate of ozone oxidation of bromide ion is much higher than that of pool contaminants. Add to this the fact that although free bromine is an excellent **disinfectant** it is a very poor **oxidizing** agent. Therefore, adding higher-than-recommended levels of 15 mg/L bromide ion **and** reducing the amount of ozone dosage will provide bromine disinfection, but **not** the desired amount of ozone oxidation.

FACT #5: Ozone plus bromide ion, in recommended levels and with flocculation can provide ozone oxidation of pool contaminants and free bromine residual for the pool/spa without the use of chlorine and the added expense of ozone destruction in the aqueous phase.

FALLACY #8: Non-use of flocculation, allowing the level of bromide ion to rise significantly above the German-recommended level of 15 mg/L, and reducing the German-recommended level of ozone dosed will produce equal quality water.

Recent North American Pool/Spa Installations Using European Design Approaches With CD-Ozone

THE KARL JEWISH COMMUNITY CENTER, Milwaukee, Wisconsin

In 1987, the Peck Aquatic Facility in the Karl Jewish Community Center in Milwaukee was the first U.S. facility to start up two CD ozone water treatment systems patterned after the German DIN Standard ozone process, each treating a separate swimming pool within the same building. The main pool (171,184 gal; 6-h turnover) and the learner's pool (12,418 gal; 2-h turnover) were new pools built incorporating upflow hydraulics, ozonation, flocculation, filtration through GAC/sand media, followed by chlorination to the DIN standard requirement of between 0.2 and 0.5 mg/L residual chlorine. Details of these installations are described by Steinbruchel et al. (1991). The treatment process is identical for both pools, and is shown schematically in Figure 10. One item of interest is the fact that when these pools were installed, the State of Wisconsin had a minimum residual chlorine requirement of 0.5 mg/L, whereas the ozone treatment process is designed to utilize 0.5 mg/L as a maximum chlorine concentration. The State of Wisconsin granted special permission to operate the new process under the DIN-Standard design conditions for a period of six-months, during which time a rigorous bacteriological sampling program was effected. After only three months, however, the State approved the unrestricted operation of this CD-ozone DIN standard process, because all samples analyzed during the first

three months of operation more than met the State requirements.

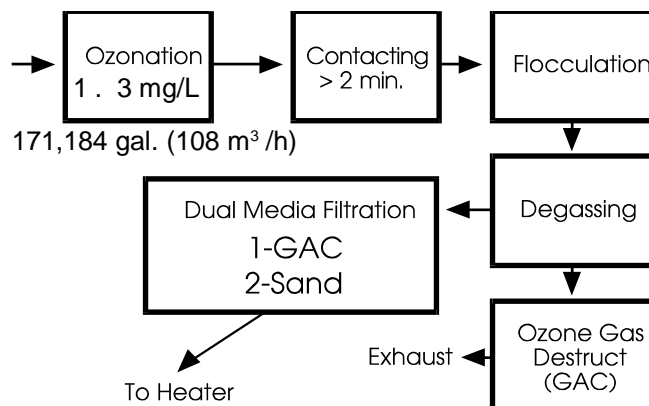

Figure 10. Schematic of ozone treatment process at Karl Jewish Community Center, Milwaukee, WI (Steinbruchel et al. 1991)

Also of interest is the fact that water pretreated with ozone and containing 0.20 mg/L residual chlorine gave more rapid destruction of *E. coli* than Milwaukee municipal tap water containing 0.4 mg/L residual chlorine and challenged similarly. Results are summarized in Figure 11.

Table IV lists the operating costs reported by Steinbruchel et al. (1991) for the first year of operation of these two pools. Note that of the total \$29.00/day consumables cost, \$15.00 is for electrical power. Pool management makes the point, however, that most of this cost is for the pumps. The 200 g/h German-made ozone generator supplying both pools consumes about 22 watts/g of ozone generated, which amounts to about 2.9 kWh. This is significantly lower than the electrical power used for pumping.

Item	Approximate Consumption	Operating Cost \$ per day
Electric Power	300 kWh/day	15.00
pH Control (Muriatic Acid)	30 gal/2 weeks	4.20
Flocculant (Aluminum Sulfate)	20 lbs/2 weeks	0.80
Chlorine (12.5% NaOCl)	80 gal/2 weeks	5.50
City Water	4,000 gal/day	3.50*
Total Consumables Cost		\$29.00/day
*There is no sewer charge for the water discharged.		

TABLE IV. Consumables Costs at Peck Aquatic Center, Milwaukee, WI (Steinbruchel et al., 1991)

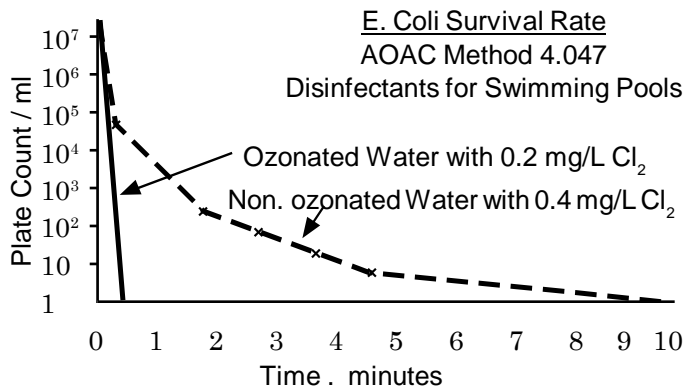

Figure 11. *E. coli* survivors in chlorinated waters with and without ozone pretreatment (Steinbruchel et al. 1991).

HOT SPRINGS LODGE & POOL, Glenwood Springs, Colorado

This large natural mineral water hot springs resort installed a DIN-Standard ozonation system in 1991 for treating the world's largest hot springs-fed swimming pool for the following reasons:

1. The suppliers of gaseous chlorine had dwindled down to a single source, as it had become increasingly difficult to find a supplier willing to transport gaseous chlorine through the treacherous mountain passes and tunnels to reach this remote facility.
2. There was uncertainty whether the license for continued chlorine usage would be renewed.
3. There was deep concern on the part of lodge management with the storage of chlorine gas in close proximity to the swimming pools. On any given day there could be as many as four one-ton chlorine gas cylinders on the site.
4. There was uncertainty as to the price structure for future chlorine supplies.
5. There was great incentive to abandon chlorine treatment because of reduced insurance rates associated with ozone treatment. Indeed, liability insurance costs have decreased dramatically since the ozonation process was installed.
6. Despite meeting Colorado Health Department regulations of maintaining a 0.4 mg/L chlorine residual in the water, water quality parameters of turbidity, color (green), and overall water quality at times left much to be desired. There were frequent reports of eye and skin irritations, and isolated reports of infections.

7. There were also reports of significant algae growths which forced unscheduled pool closings, and added additional operating expenses to the pool.

Pertinent Water Quality Parameters

This mountain resort is unique in that the water fed to the two open-air pools is from a mountain hot spring. Because of this, the pools are outdoor pools, open the year round. Because the water source is from underground hot springs, considerable iron, manganese, algae spores, dissolved organics and hydrogen sulfide contaminate the raw waters. All of these contaminants are oxidized by ozone treatment installed only in the larger of the two pools. The smaller (therapy) pool employs untreated spring water.

From a hygienic standpoint, the ozone treatment system on the large pool is designed to meet the following criteria:

- Bacterial disinfection
- Viral inactivation
- Algae control
- Compliance with Colorado State health codes, which require a minimum ORP of 650 mV in the pool.

To guarantee bacterial disinfection and viral inactivation, the ozonation system is designed to meet a minimum CT value of 1.6 mg/L-min, which will guarantee inactivation of many more than 3-logs of *Giardia* cyst inactivation (if any are present) and many more than 4-logs inactivation of enteric viruses, according to the U.S. EPA requirements for ozone primary disinfection of drinking waters at 25°C (see Table II). To this writer's knowledge, this is the first swimming pool water treatment installation involving ozone in which EPA's CT surface water disinfection requirements are being required.

Water Treatment Process

This is shown schematically in Figure 12. From the balance tank, water is treated with ca. 1 mg/L of polyaluminum chlorine (PACl) flocculant just prior to ozonation. Ozone dosage at maximum loading is 1,200 g/h, reacted over a minimum two minutes retention time in a 9,000 gal reactor. Ozone is injected under vacuum using a bypass turbine pump, a Venturi injector, and a static mixer contacting device.

Application of ozone is monitored and controlled by ORP reading taken at the reactor effluent. ORP also controls the pH (adjusted by manual addition of HCl). Output of the ozone generator can be adjusted between 10 and 100 percent capacity. The majority of the time, the reactor tank outlet has an ORP level of ca. 850 mV, with ORP levels in the pool waters proper of ca. 750 mV. The pH varies between 6.9 and 7.5.

After ozonation, the water is passed through a gravity filter having a total surface area of 864 ft². The bottom part of the filter consists of sand and gravel; the upper part of granular activated carbon. The filter has four cells, one cell of which is backwashed manually each day.

Sodium hypochlorite solution is added to adjust the residual chlorine level to 0.4 mg/L.

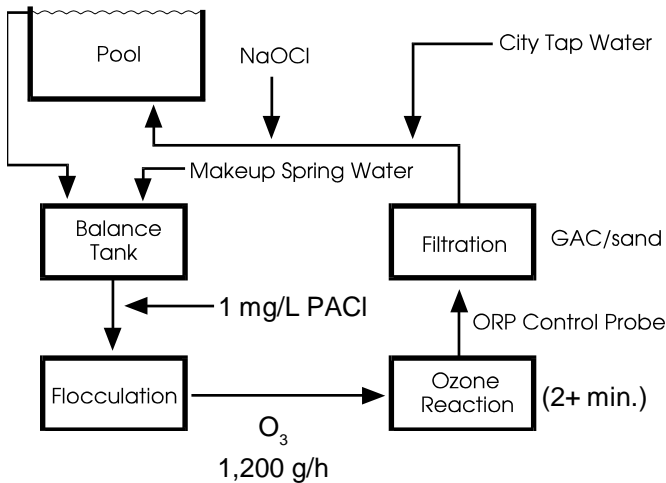

Figure 12. Schematic flow diagram of Glenwood Springs ozone treatment process (G.B. Moldzio, Private Communication 1992).

Pool Dimensions and Hydraulics

The total volume of this outdoor pool is 1,072,300 gallons, occupying a total area of 30,195 ft². The pool is 405 ft. in length and 100 ft. at its widest point. The hot springs water flows naturally at the rate of 3.5 mgd. The average pool water temperature is regulated (by dilution with city tap water) at 90°F (32°C) in winter and 86–89°F in summer. Temperature of the springs water is 124–130°F. The Hot Springs Lodge & Pool at Glenwood Springs is situated at 6,000 ft. above sea level. The average number of people visiting the pool throughout the year is between 1,000 and 1,300 per day, which sometimes rises as high as 3,000 people during holidays.

Pool turnover is designed for four hours with a flow rate of 4,500 gal/min. Makeup water per day is ca. 500,000 gal, supplied by the natural hot spring. Most of this water is not consumed or discharged to waste, however, but is believed to drain through cracks in the piping system beneath the pool (the ozonation system was retrofit and was not part of a new pool design).

System Performance

Although this system has only been in operation for a few years, the quality of water produced has

shown a striking change in color from green to dark blue; and even though the pool is situated outdoors, algae control has been excellent. This is attributed to the combination of ozone destruction of algae spores followed by maintenance of 0.4 mg/L of chlorine residual (ORP levels between 850 and 750 mV).

KAREN MAGNUSSEN AQUATIC COMPLEX, North Vancouver, BC, Canada

This is a totally enclosed facility containing one large wavepool, an exercise pool, a tots pool, a large hot whirlpool and a small hot whirlpool. Total volume of water contained by these five pools is 100,000 gallons. Each of the pools receives ozone treatment by means of an individual treatment system. Consequently, there are five individual ozone reaction systems, each of which provides a four minute ozone reaction time. However, ozone is provided for all five reactors from a single ozone generator capable of producing 90 g/h.

Ozone is applied by the so-called Slipstream (partial ozone injection) approach, by which about 25% of the water from each pool is treated with ca. 2 mg/L of ozone for a period of four minutes. After leaving the ozone reaction tank, the water still containing ozone is blended with the balance of the water (75%) from the specific pool. In this manner, all of the water for any given pool receives some ozone, albeit considerably less *in toto* than the dosage recommended by the German DIN Standard. Technical details of Slipstream ozonation can be found in a paper by Neuman (1991).

After the ozonated water is rejoined with the balance of the pool water, soda ash is added and gas chlorine, to provide a residual of 1 mg/L of total chlorine. This level sometimes decays to as low as 0.05 mg/L. Ozone reactor off-gases are separated through float valves, then sent to GAC off-gas destruction.

Treatment of these pool waters is continuous, 24-hours/day, whether or not the pool is open to receive bathers. In this context, it is important to appreciate that this Slipstream treatment does not involve balance tanks, with their associated partial discharge and constant addition of makeup water, as required by the DIN-Standard process. The only water lost from this system, other than by evaporation, is discharged during filter backwashing, which is conducted weekly. At that time, some 2,500 gallons of water are discharged from a total pool water volume of ca. 100,000 gal. Once each year, however, all British Columbia pools are required to shut down for annual cleaning and maintenance. At this time, waters are discharged as well.

The wave pool and exercise pool turn over every four hours; the two hot whirlpools turn over every 20 minutes.

An ORP probe controls pH and chlorine addition, with the probe placed after the filtration step. Thus, ORP is not used to control ozone addition – this is fixed at the rate designed to provide ozone to the 25% of the recirculating water.

The writer visited this complex about two months after start-up and on a Sunday morning prior to opening of the complex to the public for the day. The waters were clear, blue, and there was no odor of chloramines. Many natural plants were noted growing in the facility, which showed no signs of being adversely affected by their environment. A snack bar is located in the pool area, indicating that its human customers must not mind eating in the atmosphere of this enclosed pool/spa hall.

As stated by Neuman (1991) in describing Slipstream ozonation, the process produces something less than DIN Standard water quality. On the other hand, the costs for Slipstream ozonation are considerably lower than those for a DIN standard process.

This installation is new, not a retrofit situation, and began operations in April/May 1992.

WESTMINSTER AQUATIC FACILITY, Westminster, Colorado

This three-pool, two whirlpool totally enclosed facility was constructed in the mid-late 1980s and utilized standard chlorine treatment in the diving pool, the main pool, and the children's pool. UV/H₂O₂ treatment was installed in the two whirlpools. Unique to this facility is the presence of waterfalls and sprays, along with water slides and other facilities, all of which can aerosolize pool/spa waters.

In 1989, lifeguards at this facility developed a heretofore unidentified lung irritation, which was diagnosed as *Hypersensitivity pneumonitis* (HP). The facility was closed down and major renovations in air handling equipment were installed. Several months after restart in 1990, new life guards developed the same HP symptoms.

The facility was again shut down and a full German DIN standard treatment process involving ozone was installed to service the three pools. The diving pool overflows into the main pool; consequently, these two pools are serviced by the same water treatment system. The children's pool is serviced by a second DIN standard ozone treatment system.

Westminster's Aquatic Center reopened again in September 1992. The new lifeguards hired were monitored by the Colorado Department of Health for 10 months. Through questionnaires and interviews and by consulting medical examinations, the Colorado Department of Health concluded that further active surveillance of pool employees was not necessary, and full approval to operate the Westminster Aquatic Facility was given.

The Journal of the Swimming Pool and Spa Industry

Water quality tests show that the ozone-based treatment system produces superior water quality when compared with other pool water treatment systems. Endotoxin measurements have shown (McGregor et al. 1993) that the water in the improved system contains an average of less than 1.0 nanogram per mL, which is 100 times lower than the pool's reading the first time the city had to close the pools, and 50 times lower than in the control pools using standard chlorine disinfection in the Denver metropolitan area. It is also 20 to 30 times lower than levels measured following improvements to the air handling system alone. These data also indicate to the city that endotoxin measurements in the range of 20 to 30 nanograms/mL can be an indication of an impending problem in any chlorinated pool system, and further investigation may be required.

The City of Westminster believes that endotoxins are present in chlorinated pool waters because of partial oxidation of the microorganisms, releasing endotoxins into the water. On the other hand, when ozone, a much stronger oxidizing agent than chlorine, is employed under German-recommended dosages and reaction times, not only is disinfection accomplished, but the microorganisms are oxidized to a more complete extent than by chlorine, thus resulting in much lower endotoxin levels (W.D. Walenczak, City of Westminster, CO, private communication, 1993). As a matter of routine, endotoxin levels are monitored monthly in this facility. Whenever levels show a tendency to rise, the city simply increases the ozone dosage until the endotoxin levels fall.

Since the HP problem in the three Westminster Aquatic Center swimming pools has been eradicated by the new ozone-based treatment system, the city has retrofit a smaller ozonation system into its whirlpools. This part of the facility was reopened during 1994 with equally successful results.

The treatment process for the Westminster Aquatic Complex is basically the same as for the two pools at the Karl Jewish Community Center (Figure 10).

TWO RESIDENTIAL POOLS AND SPAS, Denver, Colorado

The Bromofloc (ozone/bromide ion) process was installed during 1991 in two residences in Denver. Both systems have 12.5 g/h ozone generation capabilities, which provides a maximum ozone dosage of 1.25 mg/L, at a water recirculation rate of 45 gal/min.

One of these installations is a 13 x 13 ft. Jacuzzi hot pool with water at 100°F. The second installation is a combined swimming pool (80°F) and whirlpool (102°F), with both waters being treated by the single ozonation system. Every two hours the treatment system switches automatically from treating pool water

to treating whirlpool water. Ozone for both of these installations is added in an on/off mode by ORP control. During the first 5,000 to 7,000 hours of pump operating service, the ozonation system operated only 1,500 hours (because of the start/stop operation).

Summary And Conclusions

- 1) Ozone generated by corona discharge is much higher in concentration than when generated by UV radiation, by factors of 10 to 1,000 times.
- 2) Ozone concentrations in water treated with CD-generated ozone are correspondingly higher than when treated with UV-generated ozone.
- 3) Ozone does not react with hypochlorous acid (HOCl), but does react with hypochlorite ion at reasonably rapid rates. The products are chloride ion (primarily) and chlorate ion. Ozone does not oxidize chloride ion. In the presence of 1 mg/L of free chlorine at pH 7.5, ozone has a half-life of about 5 minutes. At pH 7.0 the half-life of ozone loss by reaction with hypochlorite ion is about 15 minutes, but only 4 minutes at pH 8. Therefore, when the concentration of free chlorine is high, much of the added ozone will be destroyed by oxidizing hypochlorite ion.
- 4) Ozone does not react rapidly with hypobromous acid (HOBr), but does react with hypobromite ion at reasonably rapid rates. The products are bromide ion (primarily) and bromate ion. Ozone oxidizes bromide ion rapidly (half-life of approximately 5–6 seconds). Therefore, with HOBr present in its proper pH range (7.2 to 7.8), very little added ozone will be lost in oxidizing hypobromite ion.
- 5) Ozone reacts slowly with monochloramine (and chloramines of urea and organic aminoacids), producing chloride and nitrate ions.
- 6) Ozone reacts with monobromamine producing nitrate and bromide ions; the bromide ion is reoxidized to hypobromite ions. This sequence provides an effective way to destroy ammonia by means of ozone oxidation.
- 7) Ozone reacts with bromamines of urea and aminoacids producing bromide and nitrate ions; the bromide ion is reoxidized to hypobromite ion.
- 8) Utilizing CD-generated ozone according to the German DIN Standard process (in conjunction with chlorine) allows the free residual chlorine concentration in the pool/spa basin to be lowered to 0.2 to 0.5 mg/L, and still guarantees disinfection in the pool basin. Excess ozone and free residual chlorine are destroyed in the GAC filter. If the level of free chlorine in the pool basin is raised above this level necessary to guarantee bacterial

disinfection, additional quantities of chlorine will be required to replace that quantity destroyed by the GAC.

- 9) The CD-ozone/bromide ion process can be used with or without chemical flocculation. For residential pools and spas, CD-generated ozone can be used as the flocculating agent applied prior to filtration. This process combination does not require GAC to destroy excess ozone, because the residual bromide ion level is always high enough to react with the excess ozone (half-life = 5.6 seconds).
- 10) Systems in which UV-generated ozone is applied just as the water enters the public pool or spa basin cannot be expected to provide much additional treatment benefit. Disinfection already has been achieved by attaining the recommended free halogen residual. Reaction of ozone with haloamines and small quantities of organics refractory to chlorine will be beneficial, but only to the extent of the amount of ozone added, which is insufficient to oxidize all oxidizable materials present. Some flocculation benefit may occur, improving the clarity of the basin water.

Acknowledgments

The author is indebted to Mr. D. Kjell Mitchell, General Manager of the Hot Springs Lodge & Pool at Glenwood Springs, CO, and to Mr. Günter B. Moldzio, President of BiOzone Corporation, Englewood, CO for providing information and data on the Glenwood Springs, CO facility, to Steve Isherwood of Ideal Distributors, North Vancouver, BC, for providing information on the Karen Magnusson Aquatic Complex, and to Dr. Wolfram Hartwig of Carus Chemical Company, Ottawa, IL for providing information and data on the two Bromofloc (ozone/bromide ion) residential installations in Denver, CO.

References

- Barlow, P.J. "Treatment of Swimming Pools with Ozone and Bromine – A Case Study." in *Ozone in Water and Wastewater Treatment Vol. 2, Proceedings of the Eleventh Ozone World Congress, San Francisco*. (Stamford, CT: International Ozone Association, Pan American Group, 1993). pp. S-12-1 to S-12-23.
- Carlins, J. J. and R. G. Clark. "Ozone Generation by Corona Discharge" in *Handbook of Ozone Technology and Applications*. Vol. 1 R. G. Rice and A. Netzer, Editors. (Ann Arbor, MI: Ann Arbor Science Publishers, Inc., 1982), pp. 41–75.

- Department of the (British) Environment. *Swimming Pool Disinfection Systems Using Ozone With Residual Chlorination. Monitoring the Efficiency of Disinfection.* (London, England: Her Majesty's Stationary Office, 1982), pp. 21–24.
- Dimitriou, M. A. *Design Guidance Manual for Ozone Systems.* Stamford, CT: International Ozone Association, 1990.
- Eichelsdörfer, D. and Th. von Harpe. "Action of Ozone on Urea with Regard to Pool Water Treatment" *Vom Wasser.* 37, 1970. pp. 73–81.
- Eichelsdörfer, D. and K. E. Quentin. "Research and Development of Swimming Pool Water Treatment. The Research Pool at the Institute for Water Chemistry and Chemical Balneology at the Technical University of Munich" *Archiv des Badewesens.* Vol. 35, 1982. pp. 366–373.
- Eicheldörfer, D. and J. Jandik. "Long Contact Time Ozonation for Swimming Pool Water Treatment" *Ozone: Science & Engineering.* 7(2) (1985) pp. 93–106.
- Eliasson, B. and U. Kogelschatz. "Ozone Generation with Narrow-Band UV Radiation." *Ozone: Science & Engineering* 13(3) (1991): 365–373.
- Elphick, A. "Operator Training" *Recreation.* 50(5) (1991) pp. 12–16.
- Gilbert, E. "Chemical Changes and Reaction Products in the Ozonation of Organic Water Constituents" in *Oxidation Techniques in Drinking Water Treatment.* W. Kühn and H. Sontheimer, Editors. U.S.EPA Report #EPA-570/9-79-020 (1979). pp. 232–270.
- Haag, W. R. and J. Hoigné. "Ozonation of Bromide-containing Waters: Kinetics of Formation of Hypobromous Acid and Bromate" *Environmental Science Technology.* Vol. 17, 1983. 261–267.
- _____. "Kinetics and Products of the Reactions of Ozone with Various Forms of Chlorine and Bromine in Water" *Ozone: Science & Engineering.* 6(2) (1984) pp. 103–114.
- Hoigné, J. "Behavior of Inorganic Ions and Disinfection Agents upon Ozonation of Water (Review)" *Gaz-Eaux-Eaux Usées.* Vol. 65(12), 1985. pp. 773–778.
- _____. "The Chemistry of Ozone in Water" in *Process Technologies for Water Treatment.* S. Stucki, Editor. (New York, NY: Plenum Publishing Corporation). pp. 121–143.
- Hoigné, J., H. Bader, W. R. Haag, and J. Staehelin. "Rate Constants of Reactions of Ozone with Organic and Inorganic Compounds in Water – III. Inorganic Compounds and Radicals" *Water Research.* Vol. 19(8), 1985. pp. 993–1004.
- Hoigné, J. and H. Bader. "Ozonation of Water: 'Oxidation–Competition Values' of Different Types of Waters Used in Switzerland" *Ozone: Science & Engineering.* 1(4) (1979) pp. 357–372.
- Maier, D. "Microflocculation by Ozone" in *Handbook of Ozone Technology and Applications Vol. II.*, R. G. Rice and A. Netzer, Editors. (Stoneham, MA: Butterworth Publishers, Inc., 1984). pp. 123–140.
- Masschelein, W. J. "Thermodynamic Aspects of the Formation of Ozone and Secondary Products of Electrical Discharge" in *Ozonization Manual for Water and Wastewater Treatment.* (New York, NY: John Wiley and Sons, 1982). pp. 9–12.
- _____. "Contacting of Ozone with Water and Contactor Offgas Treatment" in *Handbook of Ozone Technology and Applications. Vol. 1.*, R. G. Rice and A. Netzer, Editors. (Ann Arbor, MI: Ann Arbor Science Publishers, Inc., 1982), pp. 143–224.
- McGregor, F.R., W.D. Walenczak, R. Rogers, and L. Magnetti. "Case Study: Ozone-Based Water Treatment for High-Quality Air and Water in a Municipal Swimming Center" in *Ozone in Water and Wastewater Treatment Vol. 2, Proceedings of the Eleventh Ozone World Congress, San Francisco.* (Stamford, CT: International Ozone Association, Pan American Group, 1993). pp. S-12A-1 to S-12A-8.
- Miller, G. W., R. G. Rice, C. M. Robson, R. L. Scullin, W. Kühn, and H. Wolf. "An Assessment of Ozone and Chlorine Dioxide Technologies for Treatment of Municipal Water Supplies." U.S.EPA Report #EPA-600/2-78-147 (1978).
- Mitchell, P. K. "Bromination – Two Methods Available for Sanitizing." *Pool and Spa News*, April 15, 1985. pp. 128–129.
- Neuman, C. M. "Slipstream Ozonation: An Economic Approach to the Production of Superior Quality Swimming Pool and Tap Water by the Use of Ozone." presented at NSPI 1991 Conference and Education Program, Nov. 21, 1991 (Alexandria, VA: National Spa and Pool Institute).
- Pacik, D. and R. G. Rice. "The Hydrozon-Kompakt Process – A New Method for Treatment and Disinfection of Swimming Pool and Bathing Water" *Ozone: Science & Engineering.* Vol 13(1) (1991): 63–90.
- Rice, R. G. and M. Gomez-Taylor. "Occurrence of By-Products of Strong Oxidants Reacting with Drinking Water Contaminants – Scope of the Problem" *Environmental Health Perspectives.* 69 (1986): 31–44.
- Rodriguez, J. and S. R. Gagnon. "Liquid Purification by Ultraviolet Radiation and its Many Applications" in *Proceedings in Ultrapure Water,*

Expo '91 West. pp. 145–153.

Singer, P. C. and W. B. Zilli. "Ozonation of Ammonia: Application to Wastewater Treatment" in *Proceedings of the First International Symposium on Ozone for Water and Wastewater Treatment*. R. G. Rice and M. E. Browning, Editors. (Stamford, CT: International Ozone Association, 1975). pp. 269–287.

Steinbruchel, A., R. G. Rice, and R. Spangenberg. "First Year Operation Report of the Corona Discharge Ozone Swimming Pool Water Treatment Systems at the Peck Aquatic Facility, Milwaukee, Wisconsin" *Ozone: Science & Engineering*. 13(4) (1991) pp. 463–478.

Stover, E. L., C. N. Haas, K. L. Rakness, and O. K. Scheible. *Design Manual—Municipal Wastewater Disinfection*. U.S. EPA Report #EPA/625/1–86–021 (Cincinnati, OH: U.S. EPA, Water Engineering Research Laboratory, 1986). p. 100.

U.S. Environmental Protection Agency. "National Primary Drinking Water Regulations; Filtration; Disinfection; Turbidity; *Giardia lamblia*, Viruses, *Legionella*, and Heterotrophic Bacteria, Final Rule" *Federal Register*. 54(124):27485–27541 (1989).

U.S. Environmental Protection Agency. "Guidance Manual for Compliance with the Filtration and Disinfection Requirements for Public Water Systems Using Surface Water Sources" for U.S. EPA, Science and Technology Branch, Criteria and Standards Division, Office of Drinking Water, (Denver, CO: American Water Works Association, October 1990).

About the Author

Dr. Rip G. Rice is President of his own ozone consulting firm, RICE International Consulting Enterprises, which was established in 1972. He is a cofounder of the International Ozone Association (1973), and is Editor-in-Chief of *Ozone: Science & Engineering* and *Ozone News*, which are the journal of the IOA, and its bimonthly newsletter, respectively.

Rice International Consulting Enterprises was instrumental in the adoption of German water treatment processing for the two swimming pools at the Karl Jewish Community Center, Milwaukee, WI, which were installed in 1987. Dr. Rice also has advised the City of Westminster, Colorado on the use of German swimming pool and whirlpool water treatment with ozone to overcome problems associated with *Hyper-sensitivity pneumonitis* (farmer's disease), a lung disease which results in chronic coughing.

He has authored or coauthored many papers describing the chemistry of ozone with respect to pool and whirlpool water treatment, and prepared the final draft of the Recommended Code of Practice for Public Spas using Ozone for the National Environmental Health Association (June 1989).

Since January 1992, Dr. Rice has been a member of the National Spa & Pool Institute (NSPI) Chemical Treatment and Process Subcommittee of the NSPI Technical Council. In this position, he provides technical advice on the use of ozone for treatment of swimming pools and spa waters for the NSPI.

Publishing Note:

The information presented in this paper has been used as a handout by Dr. Rice at various seminars on pool and spa water treatment since 1988, and is updated periodically.

